







F50		x2
E4	 6x8	x4
T10	 φ8x50 φ4,5x60	x2
K2	 7x70	x5
L6		x2
S11	 4x25	x8

Nr	Ausmaß			St
1	1000	290	15	1
2	1000	290	15	1
3	800	190	18	1



1

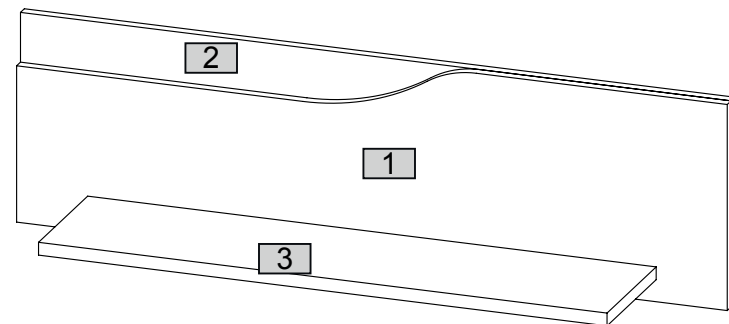
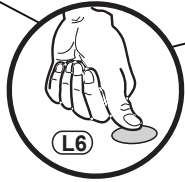
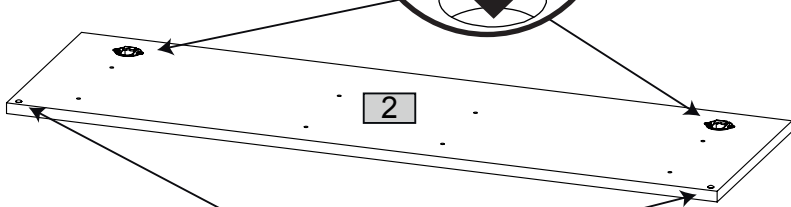
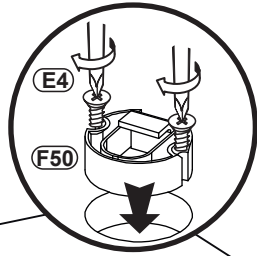
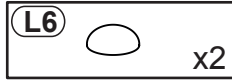
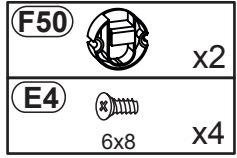

2

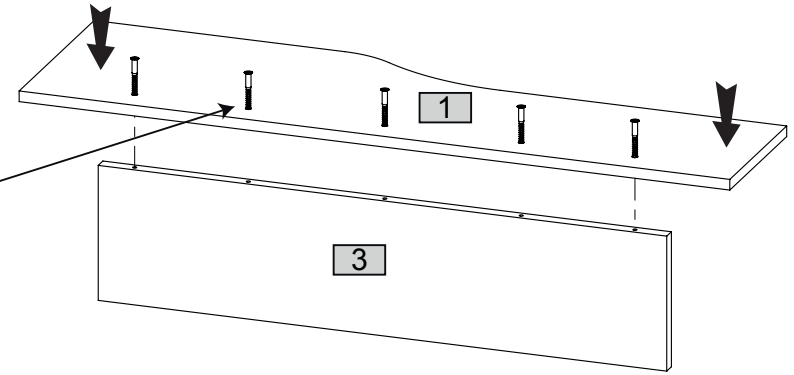
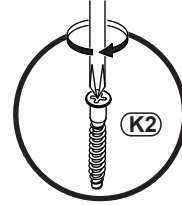
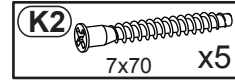

3

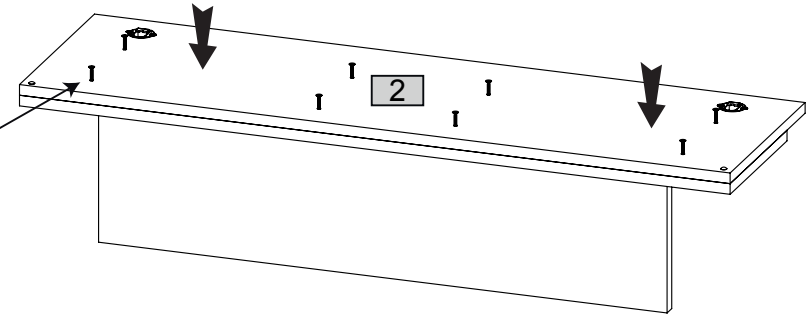
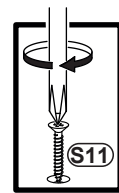
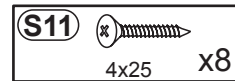

4

